

Model 1700 Series

Non-Contact/Amplified Output Torque Transducer



DESCRIPTION

These transducers are suitable for laboratory applications as well as industrial environments because of their compact size and multiple mounting options. The contactless transmission of supply voltage and measuring signal enables continuous operation with low maintenance.

FEATURES

- 0.02 Nm to 1500 Nm capacity range
- 0.1% accuracy
- Built-in instrumentation amplifier (± 10 V output) (standard)
- Speed sensor or angle encoder option
- Contactless
- Compact size
- Wide application range

Model 1700 Series

PERFORMANCE SPECIFICATIONS

Characteristic	Measure
Torque range	0.02, 0.05, 0.1, 0.2, 0.5, 1, 2, 5, 10, 20, 50, 100, 200, 300, 500, 1000, 1500 Nm

ENVIRONMENTAL SPECIFICATIONS

Characteristic	Measure
Temperature, operating	0 °C to 60 °C [32 °F to 140 °F]
Temperature, compensated	5 °C to 45 °C [41 °F to 113 °F]
Temperature effect, zero	0.02 %/°K
Temperature effect, span	0.01 %/°K

ELECTRICAL SPECIFICATIONS

Characteristic	Measure
Supply voltage	12 Vdc ±10 %
Current consumption	less than 200 mA
Rise time	2 ms*
Limit frequency (3dB)	200 Hz
Voltage output	0 V to ±10 V
Internal resistance	100 ohm
Ripple	<100 mVpp
Overall accuracy	<0.1 %

* Standard rise time is 2 ms for all transducers 1700 to 1706, in combination with limit frequency 200 Hz.

MECHANICAL SPECIFICATIONS

Characteristic	Measure
Mechanical overload	200 % of rated output

SPEED SENSING (RPM) (S) OPTION

Characteristic	Measure
Speed max.	10000 RPM
Output	Open collector
Internal pull-up	100 kOhm (5 V level)
External pull-up	24 V max.
I max.	20 mA
Pulses/rev.	60

ANGLE (E) OPTION

Characteristic	Measure
Speed max.	3000 RPM
Pulses/rev.	360
Resolution	1°
Phase shift	Quadrature

TECHNICAL SPECIFICATIONS

Model	Range (Nm)	Spring constant C (Nm/rad)	Mass moment of inertia (g•cm ²)	Maximum permissible axial load (N)	Maximum permissible radial load (N)
1700	0 to 0,02	16	7	35	30
1700	0 to 0,05	16	7	35	30
1701	0 to 0,1	35	10	140	3
1701	0 to 0,2	35	10	140	3
1701	0 to 0,5	45	10	160	4
1701	0 to 1	90	10	210	7
1701	0 to 2	135	10	210	13
1702	5	960	100	1200	15
1702	10	2115	100	1300	30
1702	20	3955	100	1300	60
1703	50	17 x 10 ³	775	1800	125
1703	100	30 x 10 ³	785	1800	215
1703	200	54 x 10 ³	810	1800	450
1703	300	67 x 10 ³	840	1800	650
1706	500	260 x 10 ³	9835	4150	650
1706	1000	387 x 10 ³	10140	4150	1275
1706	1500	449 x 10 ³	10380	4150	1700

Non-Contact/Amplified Output Torque Transducer

MOUNTING DIMENSIONS

	1700	1701	1702	1703	1706	
Model dimensions	0.02/0.05 Nm	0.1/0.2/0.5/1 Nm	2 Nm	5/10/20 Nm	50/100/200/300 Nm	500/1000/1500 Nm
L mm	82	89	95	145	170	270
B mm	32	28	28	42	56	88
H mm	47	48,5	48,5	58	73	104
H1 mm	14	14	14	21	28	44
D1 g6 mm	Ø3	Ø5	Ø6	Ø15	Ø26	Ø45
D2 g6 mm	Ø3	Ø8	Ø8	Ø15	Ø26	Ø45
D3 - 0,1 mm	Ø15	Ø27	Ø27	Ø38	Ø54	Ø80
D4 H7 mm	-	Ø2	Ø2.5	-	-	-
LK ±0,1 mm	*	Ø32	Ø32	Ø46	Ø65	Ø98
L1 mm	63	62	62	79	72	84
L2 mm	7.5	10	14	30	45	85
L3 mm	7.5	11	14	30	45	85
L4 mm	67	66	66	83	78	90
L5 -0,1 mm	-	4	5	-	-	-
A1 mm	50	40	40	60	42	46
A2 mm	24	22	22	32	40	70
M1	M2.5 x 5 deep	M3 x 5 deep	M3 x 5 deep	M3 x 6 deep	M4 x 8 deep	M6 x 12 deep
M2	M2.5 x 5 deep	M3 x 6 deep	M3 x 6 deep	M3 x 6 deep	M4 x 8 deep	M6 x 12 deep
P (DIN6885)	-	-	-	2 x A5 x 5 x 25	2 x A8 x 7 x 40	4 x A14 x 9 x 80

* consult factory

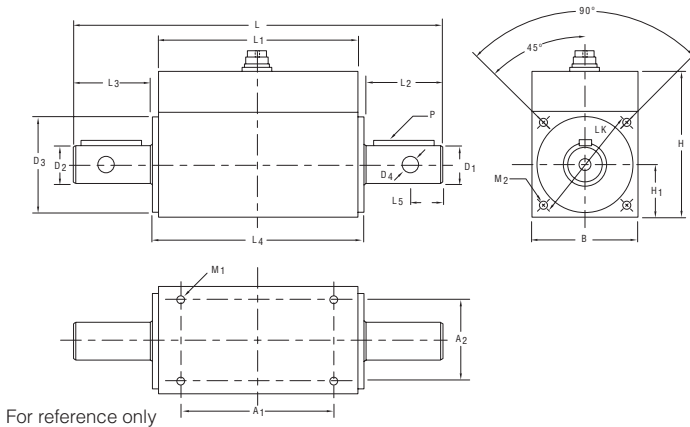

For reference only

TYPICAL SYSTEM DIAGRAM

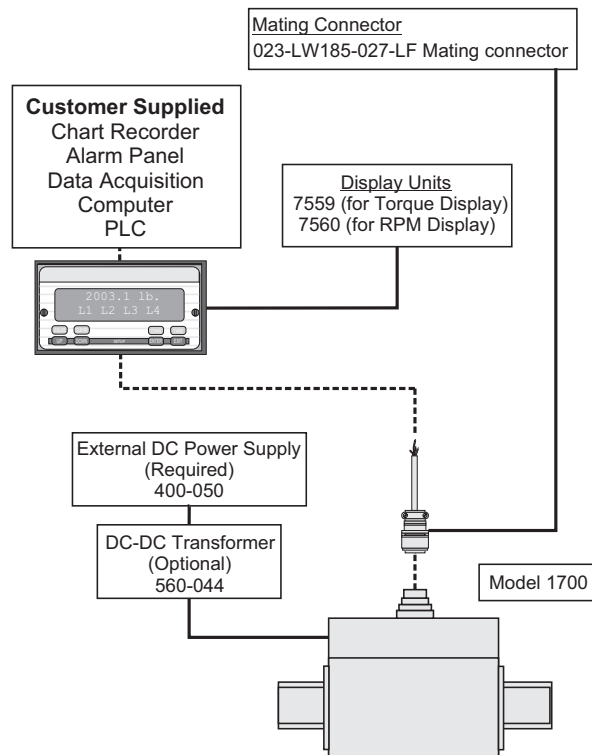

Model 1700 Series

Non-Contact/Amplified Output Torque Transducer

Warranty. Honeywell warrants goods of its manufacture as being free of defective materials and faulty workmanship. Honeywell's standard product warranty applies unless agreed to otherwise by Honeywell in writing; please refer to your order acknowledgement or consult your local sales office for specific warranty details. If warranted goods are returned to Honeywell during the period of coverage, Honeywell will repair or replace, at its option, without charge those items it finds defective. **The foregoing is buyer's sole remedy and is in lieu of all warranties, expressed or implied, including those of merchantability and fitness for a particular purpose. In no event shall Honeywell be liable for consequential, special, or indirect damages.**

While we provide application assistance personally, through our literature and the Honeywell web site, it is up to the customer to determine the suitability of the product in the application.

Specifications may change without notice. The information we supply is believed to be accurate and reliable as of this printing. However, we assume no responsibility for its use.

Find out more

Honeywell serves its customers through a worldwide network of sales offices, representatives and distributors. For application assistance, current specifications, pricing or name of the nearest Authorized Distributor, contact your local sales office. To learn more about Honeywell's test and measurement products, call **+1-614-850-5000**, visit **<http://measurementsensors.honeywell.com>**, or e-mail inquiries to **info.tm@honeywell.com**

Sensing and Control
Honeywell
1985 Douglas Drive North
Golden Valley, MN 55422
www.honeywell.com

WARNING

PERSONAL INJURY

- DO NOT USE these products as safety or emergency stop devices or in any other application where failure of the product could result in personal injury.

Failure to comply with these instructions could result in death or serious injury.

WARNING

MISUSE OF DOCUMENTATION

- The information presented in this datasheet is for reference only. DO NOT USE this document as product installation information.
- Complete installation, operation and maintenance information is provided in the instructions supplied with each product.

Failure to comply with these instructions could result in death or serious injury.

Honeywell